

Zimmer Biomet Sinus Lateral Approach (SLA) Kit Instructions for Use

Description

The Sinus Lateral Approach Instrument Kit contains surgical instruments that are used to create osteotomy in order to access maxillary sinus floor, elevate the Schneiderian membrane and create space for placement of bone graft.

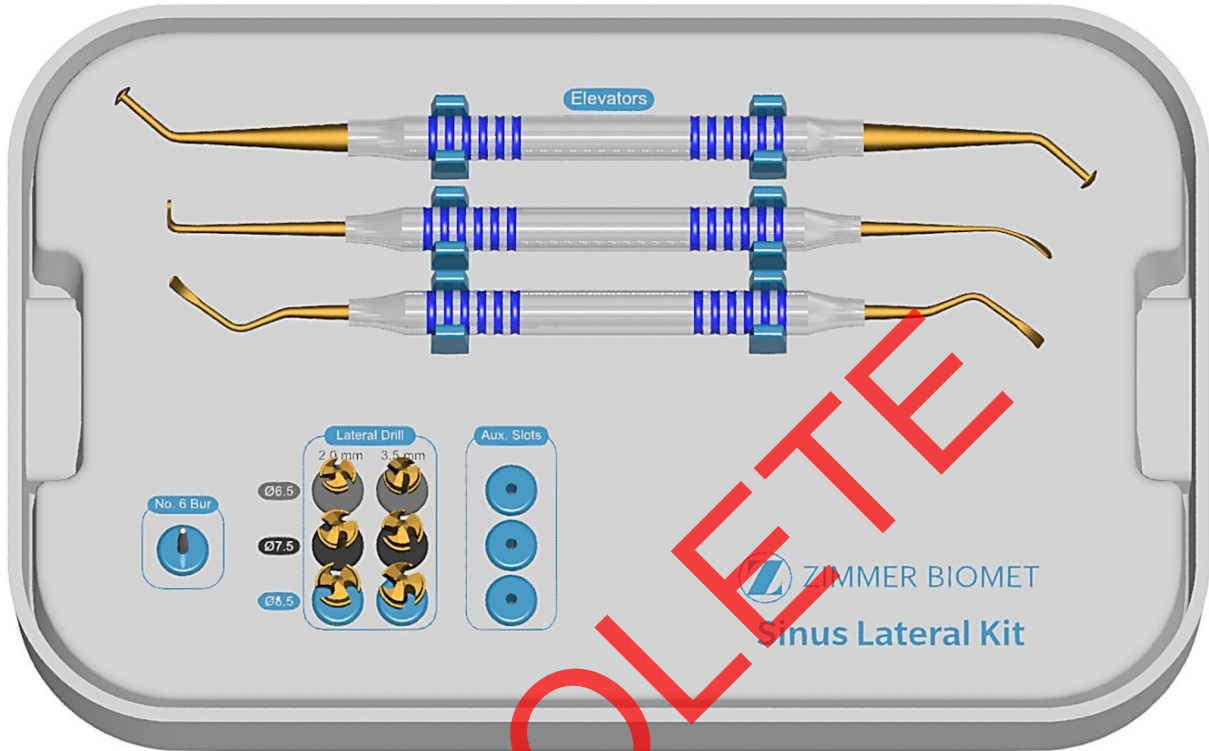

Intended Use:

Lateral maxillary subantral augmentation or "Sinus lift" procedure.

Preparation for Use

- Before using a Sinus Lateral Approach Instrument Kit and its components, the clinician performing this procedure should carefully study these instructions and fully comply with them. Before the procedure, the clinician must establish a plan based on the patient's oral and other health conditions.
- Accurately assess the residual bone height of the maxillary posterior sinus floor, anatomical structure of the maxillary sinus, artery, nerve and lateral wall thickness through computed tomography (CT) and other appropriate imaging modalities, if required.
- After taking into consideration the condition of the patient, the instruments appropriate for the procedure must be prepared.
- This product is provided non-sterile. Accordingly, it should be used only after cleaning and sterilizing in an autoclave before and after each procedure. (Please refer to cleaning and sterilization instructions.)

Sterilization Instructions

1. This product is provided non-sterile and must be sterilized prior to use by a pre-vacuum or a gravity autoclave.
2. Assembled components must be organized in the tray in order to improve the effectiveness of the sterilization.
3. Using a surgical wrap, wrap the tray, seal it with autoclave tape and sterilize using the below parameters.

Recommended Steam Sterilization Conditions

Cycle Type	Temperature	Exposure Time (minimum)
Gravity Steam Sterilization	132°C	15 minutes

If regional or national sterilization requirements are stricter than the conditions provided above, the stricter requirements must be followed.

- In order to effectively carry out high-pressure steam sterilization, the use of biological indicators at regular intervals must be considered. (Dry heat sterilization or chemical sterilization is not recommended.)
- If the above sterilization conditions are exceeded, it is possible that the plastic and metal components may be damaged. The sterilization device must be adjusted to ensure that the recommended temperatures are not exceeded.

Methods for Use

1. Expose the lateral bone at the planned osteotomy site. The osteotomy should be positioned on the most anterior and inferior site as possible to elevate the membrane effectively. It is recommended to make a lateral osteotomy at a location containing the least amount (about 1mm inferior) of cortical wall.
2. After accurately assessing the site, mark the osteotomy location using the No. 6 bur included in the kit.
3. Begin the osteotomy with the 2.0mm length lateral drill with the desired diameter. The drill is typically operated at 2000 RPM. The use of cutting tools is recommended up to 50 times.
4. The lateral drill should be used to drill until the lateral wall is completely perforated. If the shorter lateral drill does not perforate the wall, continue drilling with the 3.5mm length lateral drill with the same diameter as the shorter lateral drill.
5. Upon perforation, the remaining thin bone layer, commonly called the residual bone shield, will be formed, which may prevent the membrane from tearing. If an artery appears during drilling, it is recommended to initiate a new lateral hole at a more inferior location.
6. Detach the Schneiderian membrane using the three elevators. Use Elevator 1, Elevator 2 and Elevator 3 sequentially to achieve membrane elevation.
 - a. Elevator 1 is used to elevate the mesial and distal sides of the Schneiderian membrane.
 - b. Elevator 2: Use the L-shaped side to detach the the Scheiderian membrane from the lower part of the lateral wall, and the other end to elevate the membrane from the sinus floor, medial wall and posterior wall.
 - c. Elevator 3 is used for anterior and posterior areas.
7. Place bone graft material into the created osteotomy. Cover the lateral hole with a collagen membrane and suture soft tissue.

Note: This kit also includes three empty slots (identified as Aux. slots and located next to the lateral drills) that may be used as place holders for additional drills as desired.

Cleaning Instructions

Surgical Instruments

1. After completion of the procedure, detach all surgical instruments from the tray, soak them in alcohol or a cleaner and rinse using conventional means.
2. After washing with distilled or tap water, remove any remaining traces of blood or foreign material. Use a syringe or pipe cleaner for difficult to wash areas.
3. Following the instructions provided by the enzyme cleaner manufacturer, dilute the enzyme cleaner using tap water and after ten minutes of ultrasonic washing, rinse using tap water for three minutes.
4. Completely remove the moisture by using a dry cloth or a warm-air circulator.

Kit Tray

1. Remove all visible foreign material using distilled or tap water and a soft brush. For areas that are hard to clean, use a syringe or pipe cleaner.
2. Following the instructions provided by the enzyme cleaner manufacturer, dilute the enzyme cleaner using tap water and soak for one minute. Afterwards, remove any remaining foreign material on all parts with a soft brush.
3. After washing, rinse for three minutes using tap water to remove the remaining enzyme cleaner.
4. Completely remove the moisture by using a dry cloth or a warm-air circulator.
5. Organize the dry surgical instruments in the kit case and sterilize using the sterilization instructions.

Maintenance and Storage

- Following use, all surgical instruments must be immediately detached, washed and dried (see cleaning instructions), and stored at room temperature in a dry location away from direct light.
- Do not store in a soiled area or where there is a risk of infection.
- This product is provided non-sterile. Accordingly, it must be used only after sterilizing in an autoclave before and after each procedure. (See sterilization instructions)

Precautions

- Only healthcare professionals who have completed implant procedure education and training courses should use this product.
- For each patient, a procedure plan must be established after testing and analyzing for ailments, infectious disease, possible treatment for other ailments and presence of oral lesions.
- The healthcare professional must use the product only after becoming completely familiar with the instructions for use and the relevant warnings, and must select products that fit the treatment plan.
- Before each procedure, the tools must be examined for wear and tear.
- Improper use may cause failure of the implant or post-surgical bone loss around the implant.
- Hydrogen peroxide is prohibited for disinfection and washing, as it could damage the TiN coating, laser markings and/or anodizing.

Contraindications







- Patients with serious internal ailments: endocrine ailments such as diabetes, circulatory ailments such as hypertension and ailments related to the immune system, blood or organs
- Patients receiving high-level radiation treatment
- Patients with malocclusions
- Patients with dry mouth
- Patients with poor oral health
- Patients with acute inflammatory conditions or patients who are at risk of infection
- Patients who are pregnant
- Patients who smoke
- Patients with blood clotting conditions or with severe cardiac conditions
- Patients who are allergic to titanium or stainless steel
- Patients with abnormal wound-healing
- Patients who are taking certain medications
- Patients who are susceptible to physical and mental stress caused by temporary use of specific medications
- Patients who are emotionally unstable due to alcohol addition, drug abuse and/or neurological or mental conditions
- Patients who have unrealistic expectations regarding the treatment plan
- Children still in skeletal growth phase

Side effects

- Using sound surgical techniques minimizes the risk of complications.
- Paresthesia due to nerve damage or malocclusion, infection, edema, hypodermic bleeding, pain, opening of the sutures, soft tissue ulcer and other localized adverse reactions may occur.
- Localized and general allergic reactions may occur.

Labeling Symbols

CAUTION: Federal Law (USA) restricts this device to sale by or on the order of a physician.

Symbol	Definition	Symbol	Definition
	Catalog Number		Consult instructions for use ifu.biomet3i.com
	Batch Code		Non-Sterile
	Date of manufacture		Prescription Only
	Manufacturer		

Distributed by:
Zimmer Biomet Dental
4555 Riverside Drive
Palm Beach Gardens, FL 33410
Tel +1.561.776.6700
Fax+1.561.776.1272
www.zimmerbiometdental.com

Manufactured by:
Kaiserprecision Co.
34, Dongtansandan 5-gil, Hwaseong-si,
Gyeonggi-do
Republic of Korea
www.implant-drill.com

Sinus Lateral Kit IFU Revision June 2019

OBSOLETE